

Frontal panel

#	Code	Description	Specification	UM	Qty
1	R51FRO00004	RADAX FRONTAL STICKER	For Radax oven	pz	1
1	R51FRO00012	TATRA FRONTAL STICKER	For Tatra oven	pz	1
9	R85CRU00004	Frontal panel		pz	1
16	R20SCH00002	DISPLAY ELECTRONIC BOARD		pz	1

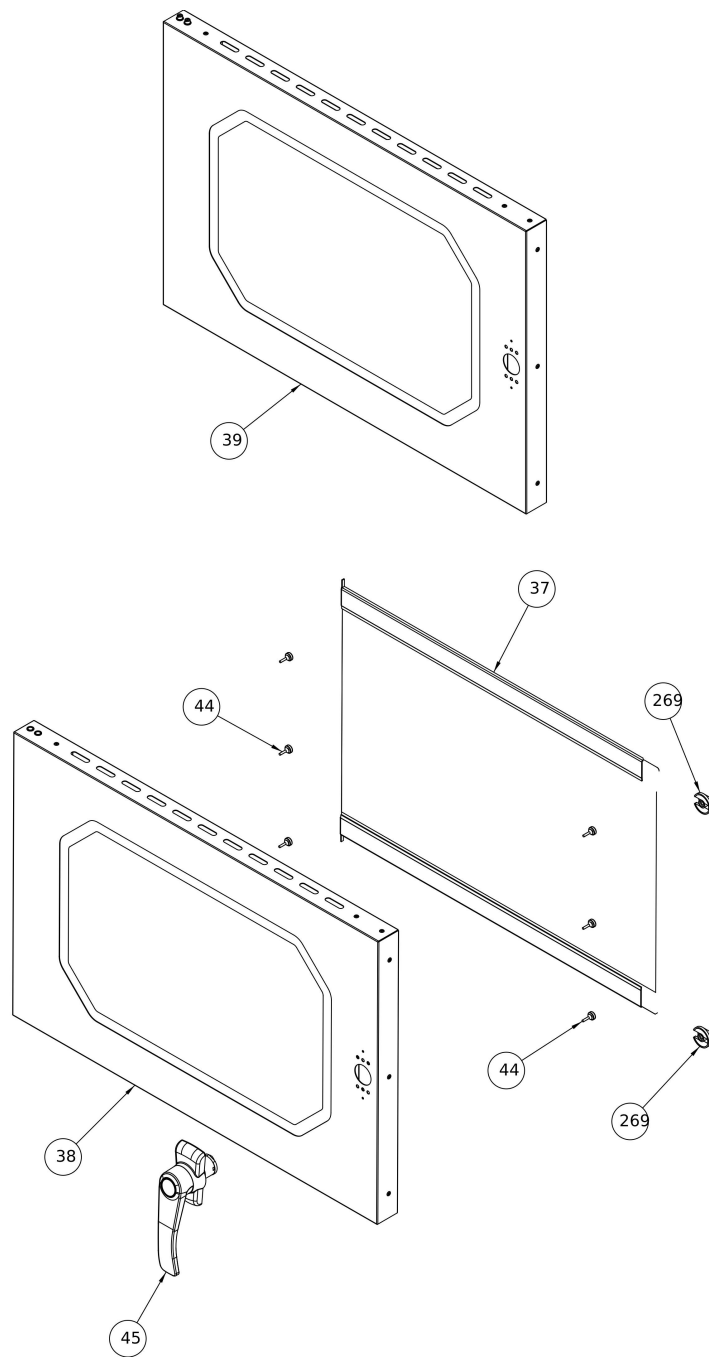

Door

#	Code	Description	Specification	UM	Qty
37	R85AVI00003	DOOR INTERNAL GLASS		pz	1
38	R85AVE00003	DOOR EXTERNAL GLASS	To order share s/n	pz	1
39	R85PTA00008	DOOR ASSEMBLY	To order share s/n	pz	1
44	040TAP00015	INTERNAL GLASS HINGE		pz	6
45	R60MNG00001	BLACK DOOR HANDLE	For Tatra oven	pz	1
45	R60MNG00002	BLUE LEFT DOOR HANDLE	For Radax oven	pz	1
269	R50PAR00007	GLASS BLOCKING KNOB		pz	2

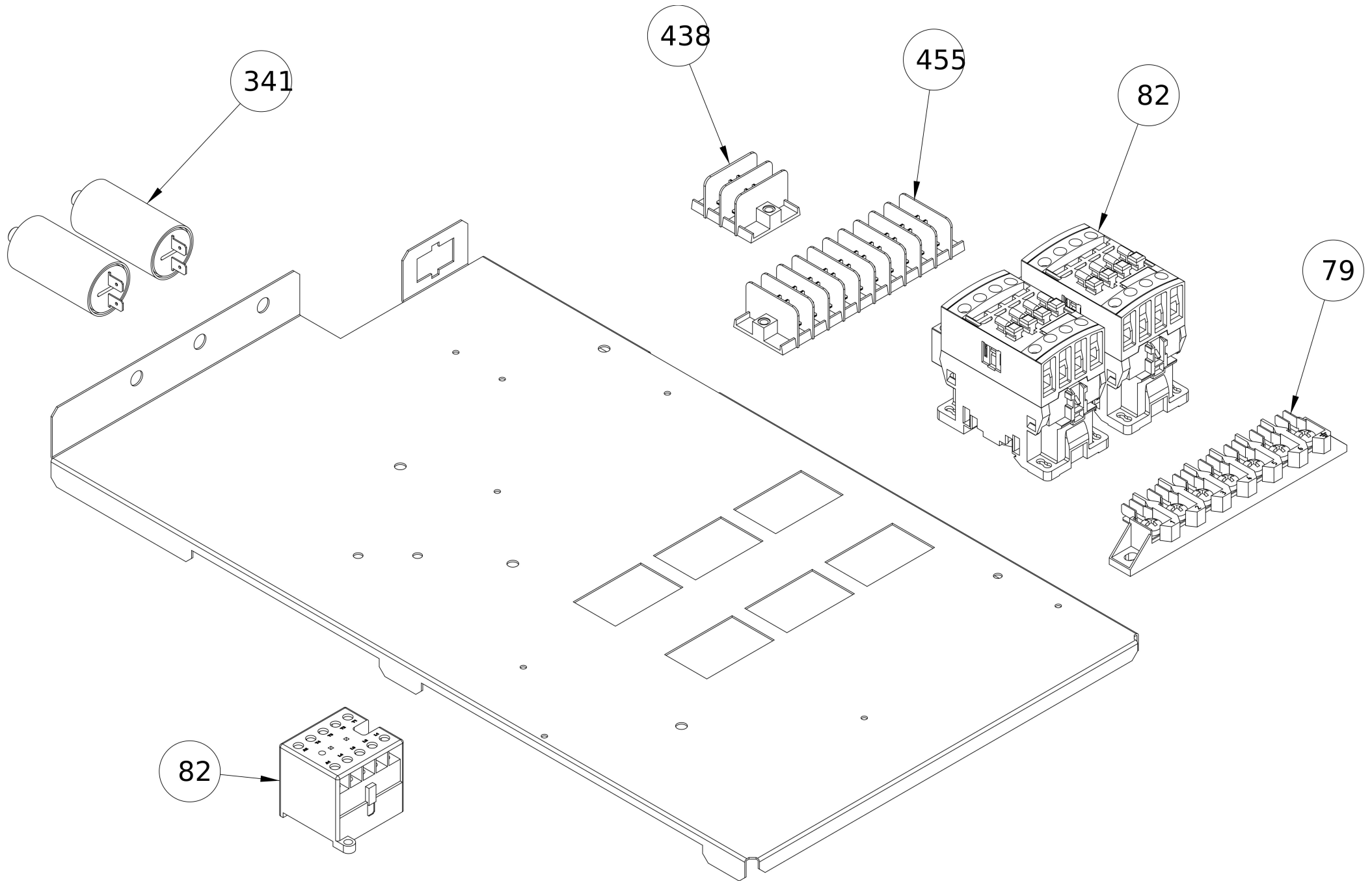

Electrical box

#	Code	Description	Specification	UM	Qty
79	R20MOR00001	TERMINAL BLOCK		pz	1
82	R20TEL00002	BRAKER		pz	2
341	R20CND00002	CAPACITOR 6,3 ?F	Single speed oven	pz	2
341	R20CND00003	CAPACITOR 8 ?F	Two speeds oven	pz	2
438	R20MOR00006	2 POLES TERMINAL BLOCK		pz	1
455	R20MOR00003	10 POLES TERMINAL BLOCK		pz	1

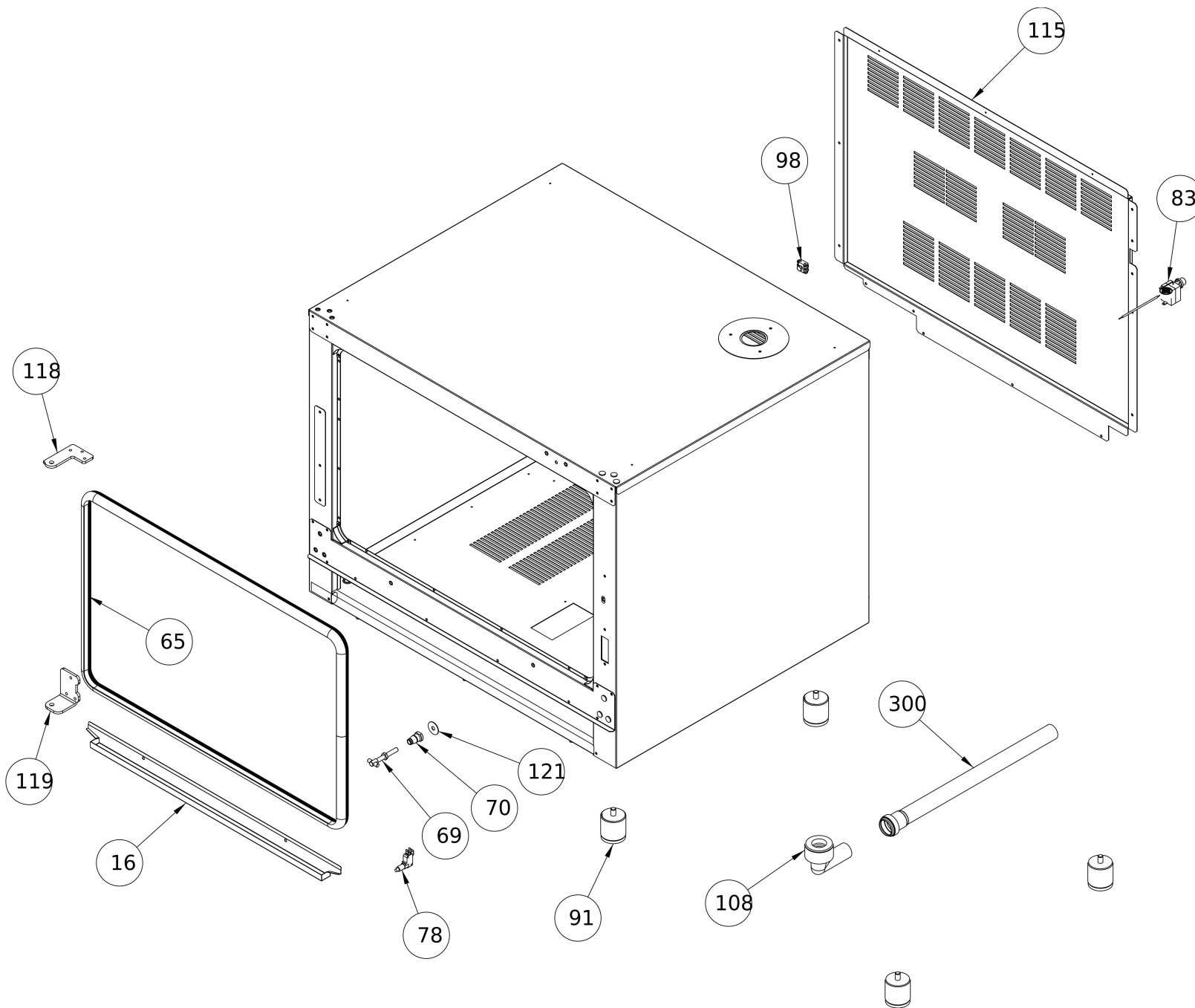

Oven body

#	Code	Description	Specification	UM	Qty
16	R20SCH00002	DISPLAY ELECTRONIC BOARD		pz	1
65	R50GUA00001	DOOR GASKET		pz	2
69	R60NAS00001	HANDLE STUD		pz	1
70	R60PER00010	HANDLE PIVOT		pz	1
78	R20PUL00002	DOOR MICRO		pz	1
83	R20REG00001	SAFETY THERMOSTAT		pz	1
91	R60PIE00002	PLASTIC FEET		pz	4
98	R20MOR00002	THERMINAL BLOCK BRIDGE		pz	1
108	R30TBS00001	BEND 90°		pz	1
115	TBC-BACK	REAR PANEL	To order share s/n	pz	1
118	R10CER00003	TOP HINGE		pz	1
119	R10CER00002	LEFT LOWER HINGE	Left hinge	pz	1
119	R10CER00007	RIGHT LOWER HINGE	Right hinge	pz	1
121	R10PIA00016	STUD PLATE		pz	1
300	R30TBS00002	DRAIN PIPE		pz	1



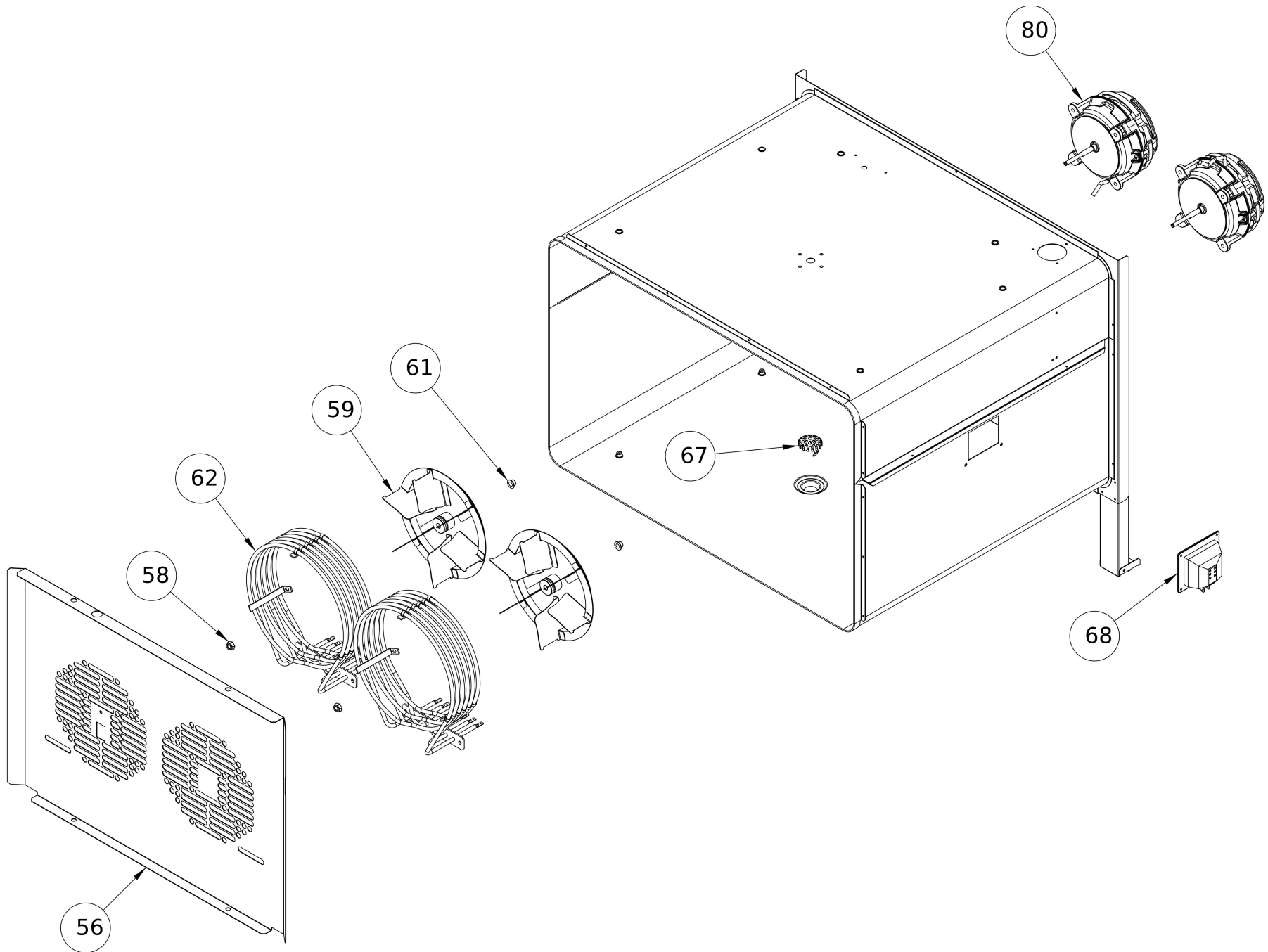

Cooking chamber

#	Code	Description	Specification	UM	Qty
56	R10DEF00010	AIR DEFLECTOR		pz	1
58	R70DAD00004	MOTOR NUT		pz	2
59	R60VEN00002	IMPELLER		pz	2
61	R60BCC00001	MOTOR BUSH		pz	2
62	R20RES00003	HEATER 5KW		pz	2
67	R85FIL00001	DRAIN PLATE		pz	1
68	R20LAM00004	LAMP		pz	1
80	R85MOT00002	1 SPEED MOTOR	Single speed oven	pz	2
80	R85MOT00003	2 SPEED MOTOR	Two speeds oven	pz	2

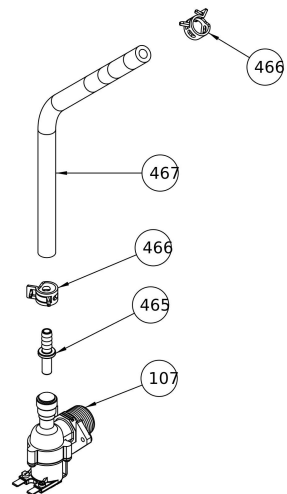
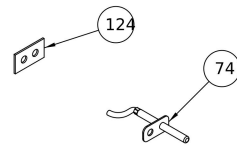
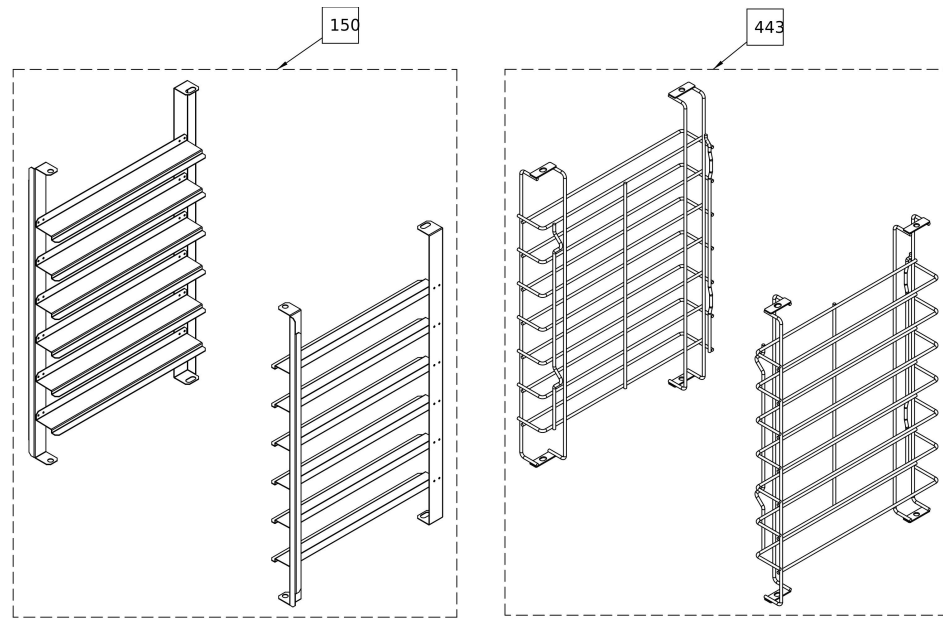

#	Code	Description	Specification	UM	Qty
74	R20SON00004	OVEN TEMPERATURE PROBE		pz	1
107	R20ELE00001	SOLENOID VALVE		pz	1
124	R50GUA00003	PROBE GASKET		pz	1
150	TBC-GRI	TRAYS HOLDER	To order share s/n	pz	2
443	TBC-GRI	TRAYS HOLDER	To order share s/n	pz	2
465	R61RCC00001	PIPE HOSE		pz	1
466	R60FAS00002	METAL CLAMP		pz	2
467	R30TBG00001	HUMIDIFICATION BLACK PIPE		pz	1